

GRABER. | DELIGHT IN
EVERY DETAIL

Graber Pleated Shades
US Price Guide

January 2026

PLEATED SHADES

Product Information Guide

Features

Fabric Styles and Information	3
Light Control and Privacy Levels	3
Fabric Disclaimers	3
Oeko-Tex® Standard 100 Certified Fabrics	3
Summary	4
Rail Colors	5

Control Type and Size Considerations

Cordless Lift- Depth Requirements for Inside Mount	6
Cordless Lift, Bottom Up/Top Down Cordless Lift	7
Sun Up/Sun Down Cordless Lift	8
Perfect-View® Cordless Lift- Depth Requirements for Inside Mount	9
Perfect-View® Cordless Lift	10
Motorized Lift	10
Continuous Loop Lift Shades- Depth Requirements for Inside Mount	11
Continuous Loop Lift	12

Options

Shade Liner	13
EvenPleat Loop Tape	13
Multiple Shades on One Headrail	13
EvenPleat Loop Tape	13
Corner Windows	14
Bay Windows	15

General Information

Specialty Shapes: Arch Shades	16
Specialty Shapes: Angled Top, SkyTrack™ Skylight	17
Making a Template for Specialty Windows	18
Using Template Service	18
Enhanced Light Control Features	19
Stack Height Chart	20
Stack Height Chart: Perfect-View®	21
Pleated Shade Color Coordination Chart	22
Cordless Lift Product Detail	23
Continuous Loop Lift Product Detail	24
Bottom Up/Top Down: Cordless Lift Product Detail	25
Perfect-View® Cordless Lift Product Detail	26

GRABER®

AUGUST 2025

(08/25) 25-678204

Features

Graber® Pleated Shades include a variety of prints and elegant weaves in fashionable colors. The unique design of the back ladder support of EvenPleat® ensures that pleats will not sag or flatten. These classic shades are an elegant addition to any window and match easily with other window treatments.

- EvenPleat back ladder support gives pleats an even, dimensional appearance
- Many fashion-inspired patterns, colors, and textures enhance any room
- Color coordinated rails and components
- Offer numerous light control and privacy levels
- Two liners offered for light control: light filtering (privacy liner) and blackout
- Two pleat sizes offered: 1" and 2" pleat (select styles)

Features	Benefits
EvenPleat® Shades	
EvenPleat Loop Tape	<ul style="list-style-type: none"> • Ensures consistent pleat spacing from top to bottom for a perfect, tailored look; pleats won't sag • Patterns remain uniform throughout the shade • No need to periodically raise the shade
Many Fabric Styles	<ul style="list-style-type: none"> • Great design flexibility • Something to suit everyone's taste and budget • Fresh color offerings in tune with today's decor trends • 2" pleat is an ideal solution for larger windows
Limited Lifetime Warranty	<ul style="list-style-type: none"> • Guarantees years of trouble-free shade operation
FashionPleat® Shades	
Many Fabric Styles	<ul style="list-style-type: none"> • Great design flexibility • Something to suit everyone's taste and budget
Three-Year Warranty	<ul style="list-style-type: none"> • Guarantees trouble-free shade operation • Product is warranted against original defects in materials or workmanship
Pleated Shades	
Aluminum Headrail System	<ul style="list-style-type: none"> • Strong, yet lightweight • Color coordinated to fabric • Extremely durable • Rail color coordination can be specified at the time of purchase
Two Different Fabric Liners Available	<ul style="list-style-type: none"> • Changes privacy level of any fabric to either Light Filtering or Blackout • Provides neutral exterior appearance regardless of interior color • Available with select 1" or 2" fabrics
Cordless Lift	<ul style="list-style-type: none"> • Eliminate external cord loops • Available on select fabrics
Continuous Loop Lift	<ul style="list-style-type: none"> • Continuous loop remains at constant length • Helps lift large, heavy shades • Sleek, low profile; color coordinated headrail is sturdy aluminum
Variety of Specialty Shades Available	<ul style="list-style-type: none"> • Coordinated hard-to-cover specialty windows for total room decor • Provides light control
Motorized Lift	<ul style="list-style-type: none"> • Provides easy operation of hard-to-reach or large windows • Eliminates external cord loops • Available with all fabrics

Features

Fabric Styles and Information

Fabric Styles	1" FashionPleat®	1" EvenPleat®	2" EvenPleat	Fabric Content	Fabric Width (inches)	Privacy Rating	Liner Available	Overlap*	Cordless Lift Available	Oeko-Tex® Certified
Aberdeen		•	•	100% polyester	92	Light Filtering	•	•	•	•
Allure	•	•		100% polyester	72	Light Filtering	•	•	•	
Canyon Ridge			•	100% polyester	92	Light Filtering	•	•	•	•
Cloud Metal			•	100% polyester	94	Light Filtering	•	•	•	•
Debonair		•	•	92.6% polyester, 4.3% cotton strap, 3.1% flax	94	Light Filtering	•		•	•
Desert	•	•	•	100% polyester	94	Light Filtering	•	•	•	•
Grasscloth			•	100% polyester	72	Light Filtering	•		•	•
Inkblot		•		100% polyester	92	Light Filtering	•		•	•
Marina			•	100% polyester	94	Light Filtering	•		•	•
Prescott			•	100% polyester	94	Light Filtering	•		•	•
Sahara Ridge		•	•	95.8% polyester 2.5% cotton strap 1.7% flax	94	Light Filtering	•		•	•
Serendipity		•	•	100% polyester	92	Sheer		•	•	
Sheer Linen	•	•	•	100% polyester	72	Sheer		•	•	
Spring Bloom		•		100% polyester	92	Light Filtering	•		•	•
Terrain		•	•	100% polyester	94	Light Filtering	•		•	•
Blackout Liner		•	•	100% polyester	72	Room Darkening		•		
Privacy Liner		•	•	100% polyester	72	Light Filtering		•	•	

*Overlaps are not available with bottom up/top down, sun up/sun down, Perfect-Vue®, and multiple shades on one headrail.

Light Control and Privacy Levels

Sheer: Allows the most sunlight and least privacy

Light Filtering: Blocks some sunlight and offers some privacy

Privacy Liner: Offers increased light control and privacy. At night, objects in your home will appear as silhouettes from the outside.

Blackout Liner: Blocks light and offers complete privacy. At night, objects in your home will not be seen from the outside.

Fabric Disclaimers

Due to the nature of fabric, some fraying on shade edges is normal. If threads come loose near the edges, use sharp scissors to trim off stray threads. To avoid fraying, ensure that your shade is not coming into contact with any surface. Fabric appearance can vary based on changing light conditions in the room. Pleat alignment among multiple shades may not be exact.

Oeko-Tex® Standard 100 Certified Fabrics

Fabric styles Aberdeen, Canyon Ridge, Cloud Metal, Debonair, Desert, Grasscloth, Inkblot, Marina, Prescott, Sahara Ridge, Spring Bloom, and Terrain are Oeko-Tex Standard 100 Certified and are free of PVC, halogen, lead, formaldehyde, allergenic dyes, pesticides, phenols, heavy metals, and meet all VOC content limits.

Oeko-Tex is a registered trademark of the Oeko-Tex Association.



Features

Summary (for surcharges and pricing, refer to price charts)

The following is a list of options for pleated shades. Most options are available in all styles and colors. Limitations will be based on fabric width and fabric type. See detailed descriptions on the following pages.

- Control Type Options** (see price charts for pricing and/or surcharges)
- Continuous loop lift
 - Cordless lift
 - Motorized lift* (see motorization product information guide)

Shade Options—No Charge

- Cord loop placement on right or left
- Custom cord loop length is available upon request at time of order
- Corner or bay window
- Hold down brackets
- Projection brackets
 - With 1" FashionPleat and 1" EvenPleat
 - Long (adds up to 2½" extension from wall)
 - Medium (adds up to 1⅝" extension from wall)
 - Short (adds up to 1" extension from wall)
 - With 2" EvenPleat®
 - Long (adds up to 2¼" extension from wall)
 - Medium (adds up to 1⅜" extension from wall)
 - Short (adds up to ¾" extension from wall)
- Rail color can be specified at the time of order
- Shims
- Side-mount brackets: inside mount only
- Lightblocking strip available with cordless lift, continuous loop lift, and motorized lift* controls

- Specialty Shape Shade Options** (see price charts for pricing and/or surcharges)
- Angled Top
 - Arches

Shade Options—Surcharge (see price charts for pricing and/or surcharges)

- Room-darkening side channels: 2" pleated; motorized* and cordless lift
- Bottom up/top down: cordless lift
- Liners
- Multiple shades on one headrail
- Perfect-Vue shade: cordless lift
- Sky pole
- Skylight shades
- Sun up/sun down: cordless lift

*See motorization product information guide for more details on available motorized options.

Control Type										
Pleat Size	Cordless Lift	Continuous Loop Lift	Motorized Lift	Bottom Up/Top Down	Sun Up/Sun Down	Perfect-Vue	Side Channels	Skylights	Arches	Angled Top
1"	•	•	•	•	•	•			•	•
2"	•	•	•	•	•	•	•	•	•	

Summary (for surcharges and pricing, refer to price charts)

Rail Colors

Rail Color Name	Rail Color #	1" Pleat Size	2" Pleat Size	2" Pleat Size: Side Channels & SkyTrack Skylight
Acacia Haze	182		•	
Arctic Seal	183	•	•	
Black Satin	233	•	•	
Bordeaux	359		•	
Camel	086		•	
Canyon Gray	053	•	•	•
Clover	049		•	
Cream	715	•	•	•
Creamy Pearl	356	•	•	•
Etched Stone	195		•	
Faded Sea Foam	198		•	
Fog	574		•	
Gray Moss	199		•	
Ice	778		•	
Iron Gate	185		•	
Lamplight	904	•	•	
Navy	369	•	•	
Online	187	•	•	
Open Seas	186		•	
Plebian Blue	221		•	
Praline	108		•	
Quietude	188	•	•	
Revere Pewter	190	•	•	•
Sable	565		•	•
Sangria	059		•	
Smokey Gray	026		•	•
Tender Taupe	103		•	
Twine	439	•	•	
Vanilla	100		•	
Watermelon Punch	196		•	
White Satin	205	•	•	•

Control Type and Size Considerations

Cordless Lift

Fabric Styles	Fabric Width (inches)	Overlap Available	Liner Available													
				Cordless Lift (inches)				Cordless Lift Multiple Shades on One Headrail (inches)					Cordless Lift Bottom Up/Top Down (inches)			
				Width		Height		Width		Height			Width		Height	
				Min [†]	Max	Min	Max	Min Panel [†]	Max Panel	Max Shade	Min Shade	Max Shade	Min [†]	Max	Min	Max
1" FashionPleat®																
Allure	72	●	●	12	96	9	86	12	72	144	9	86	15	72	9	86
Desert	94	●	●	12	96	9	86	12	94	144	9	86	15	84	9	86
Sheer Linen	72	●	●	12	96	9	86	12	72	144	9	86	15	72	9	86
1" EvenPleat®																
Aberdeen	92	●	●	12	96	6	86	12	92	120	6	86	15	84	9	86
Allure	72	●	●	12	96	6	86	12	72	120	6	86	15	72	9	86
Debonair	94	●	●	12	94	6	86	12	94	120	6	86	15	84	9	86
Desert	94	●	●	12	96	6	86	12	94	120	6	86	15	84	9	86
Inkblot	92	●	●	12	92	6	86	12	92	120	6	86	15	84	9	86
Privacy Liner	72	●	●	12	96	6	86	12	72	120	6	86	15	72	9	86
Sahara Ridge	94	●	●	12	94	6	86	12	94	120	6	86	15	84	9	86
Serendipity	92	●	●	12	96	6	86	12	92	120	6	86	15	84	9	86
Sheer Linen	72	●	●	12	96	6	86	12	72	120	6	86	15	72	9	86
Spring Bloom	92	●	●	12	92	6	86	12	92	120	6	86	15	84	9	86
Terrain	94	●	●	12	94	6	86	12	94	120	6	86	15	84	9	86
2" EvenPleat																
Aberdeen	92	●	●	12	96	12	86	12	92	144	12	86	15	84	12	86
Canyon Ridge	92	●	●	12	96	12	86	12	92	144	12	86	15	84	12	86
Cloud Metal	94	●	●	12	96	12	86	12	94	144	12	86	15	84	12	86
Debonair	94	●	●	12	94	12	86	12	94	144	12	86	15	84	12	86
Desert	94	●	●	12	96	12	86	12	94	144	12	86	15	84	12	86
Grasscloth	72	●	●	12	72	12	86	12	72	144	12	86	15	72	12	86
Marina	94	●	●	12	94	12	86	12	94	144	12	86	15	84	12	86
Prescott	94	●	●	12	94	12	86	12	94	144	12	86	15	84	12	86
Privacy Liner	72	●	●	12	96	12	86	12	72	144	12	86	15	72	12	86
Sahara Ridge	94	●	●	12	94	12	86	12	94	144	12	86	15	84	12	86
Serendipity	92	●	●	12	96	12	86	12	92	144	12	86	15	84	12	86
Sheer Linen	72	●	●	12	96	12	86	12	72	144	12	86	15	72	12	86
Terrain	94	●	●	12	94	12	86	12	94	144	12	86	15	84	12	86

[†]For all inside mount applications, 3/8" deduction is taken by manufacturer on overall width.

NOTE: Cordless lift maximum overall area for 1" Debonair is 5,400 square inches, 1" Aberdeen, Desert, Sahara Ridge, and Terrain is 6,400 square inches, 1" Serendipity is 7,000 square inches; 2" Prescott is 4,000 square inches, 2" Aberdeen, Cloud Metal, Debonair, Marina, Sahara Ridge, and Terrain is 4,800 square inches, 2" Canyon Ridge, Desert and Serendipity is 6,000 square inches, 2" Sheer Linen is 7,400 square inches.

Maximum width and height for shades with side channels is 120" x 120".

Depth Requirements for Inside Mount Cordless Lift

Shade Type	Headrail Dimensions (inches)	 Minimum Depth Mount (inches)	 Flush with Casing (inches)
1" Pleat	1 1/16" x 2 3/8"	3/8"	2 3/8"
2" Pleat	1 1/16" x 2 3/8"	3/8"	2 3/8"

Control Type and Size Considerations

Cordless Lift

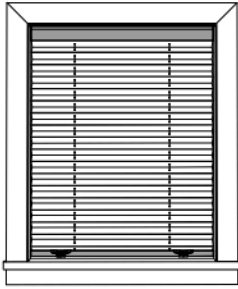

- For surcharge, see price charts
- Applies to standard, bottom/up top/down, sun up/sun down, and Perfect-View shades
- Available with the privacy liner option on single panels of fabric (no overlap)
- Cordless lift shades are the safest window shade alternative; ideal for homes with children and pets
- Overlap not available with Debonair, Grasscloth, Inkblot, Marina, Prescott, Sahara Ridge, Spring Bloom, or Terrain
- Cordless lift shades should only be used on windows where consumers can comfortably raise and lower the shade with their hand
- An optional sky pole is available for shades 24" or less in width that are hard to reach. For shades over 24" in width, two sky poles are recommended to ensure even operation.
- Room-darkening side channels are available:
 - Surcharge (see price charts)
 - Applies to standard, bottom/up top/down, sun up/sun down, and Perfect-View shades
 - 2" pleated only
 - Side channels are Canyon Gray 053, Cream 715, Creamy Pearl 356, Revere Pewter 190, Sable 565, Smokey Gray 026, or White Satin 205

Size Considerations	Minimum Width* (inches)	Maximum Width† (inches)	Minimum Height (inches)	Maximum Height (inches)
1" FashionPleat®	12	96	9	86
1" EvenPleat®	12	96	6	86
2" EvenPleat	12	96	12	86

*For all inside mount applications, 3/8" deduction is taken by manufacturer on overall width.

†Based on fabric width with overlap.

NOTE: Cordless lift maximum overall area for 1" Debonair is 5,400 square inches, 1" Aberdeen, Desert, Sahara Ridge, and Terrain is 6,400 square inches, 1" Serendipity is 7,000 square inches; 2" Prescott is 4,000 square inches, 2" Aberdeen, Cloud Metal, Debonair, Marina, Sahara Ridge, and Terrain is 4,800 square inches, 2" Canyon Ridge, Desert and Serendipity is 6,000 square inches, 2" Sheer Linen is 7,400 square inches.

Bottom Up/Top Down Cordless Lift

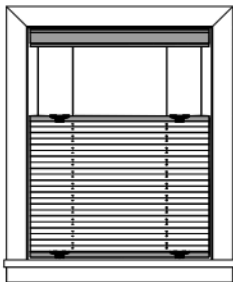

- For surcharge, see price charts
- Option allows for privacy; lets in natural light
- An optional sky pole is available for hard to reach shades 24" or less in width; if a sky pole is required for shades over 24" in width, two sky poles are recommended to ensure even operation
- Overlap not available
- Not available with multiple shades on one headrail

Size Considerations	Minimum Width* (inches)	Maximum Width† (inches)	Minimum Height (inches)	Maximum Height (inches)
1" FashionPleat	15	84	9	86
1" EvenPleat	15	84	9	86
2" EvenPleat	15	84	12	86

*For all inside mount applications, 3/8" deduction is taken by manufacturer on overall width.

†Not available with overlap.

Maximum width and height for shades with side channels is 120" x 120".

NOTE: See cordless size considerations chart for fabric specific limitations.

Control Type and Size Considerations

Sun Up/Sun Down Cordless Lift

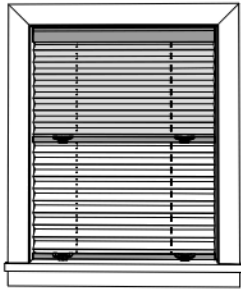

- Perfect for combining light controls of sheer or light-filtering and room-darkening fabrics
- Available with 1" or 2" pleated fabrics
- Cannot combine 1" and 2" pleat sizes
- Headrail coordinates with top fabric, bottomrail coordinates with bottom fabric, and midrail will match headrail as a default
- Overlap not available
- Not available with multiple shades on one headrail
- An optional sky pole is available for hard to reach shades 24" or less in width; if a sky pole is required for shades over 24" in width, two sky poles are recommended to ensure even operation

Size Considerations	Minimum Width* (inches)	Maximum Width† (inches)	Minimum Height (inches)	Maximum Height (inches)
1" Pleated	15	84	12	86
2" Pleated	15	84	12	86

*For all inside mount applications, 3/8" deduction is taken by manufacturer on overall width.

†Based on fabric width; narrowest of the two fabrics is the maximum width.

Maximum width and height for shades with side channels is 120" x 120".

NOTE: See cordless size considerations chart for fabric specific limitations.

Control Type and Size Considerations

Perfect-Vue® Cordless Lift

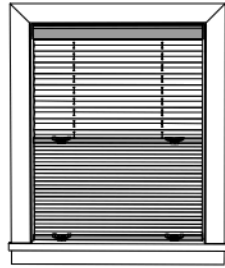
					
		Cordless Lift All Cellular Fabric Styles (inches)			
Fabric Styles (inches)	Fabric Width (inches)	Width		Height	
		Minimum†	Maximum	Minimum	Maximum
1" FashionPleat®					
Allure Sheer Linen	72	15	72	12	86
Desert	94	15	94	12	86
1" EvenPleat®					
Allure Sheer Linen	72	15	72	12	86
Aberdeen Inkblot Serendipity Spring Bloom	92	15	92	12	86
Debonair Desert Sahara Ridge Terrain	94	15	94	12	86
2" EvenPleat					
Grasscloth Sheer Linen	72	15	72	12	86
Aberdeen Canyon Ridge Serendipity	92	15	92	12	86
Cloud Metal Debonair Desert Marina Prescott Sahara Ridge Terrain	94	15	94	12	86

†For all inside mount applications, 3/8" deduction is taken by manufacturer on overall width.

NOTE: Maximum area for 1" Aberdeen, Debonair, Sahara Ridge and Terrain is 6,400 square inches; 2" Debonair and Prescott is 5,800 square inches; 2" Marina and Sahara Ridge is 7,000 square inches, 2" Aberdeen, Cloud Metal and Terrain is 7,600 square inches.

Depth Requirements for Inside Mount

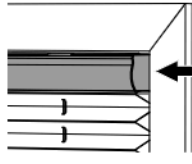
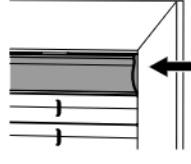
			
	Cordless Lift Shades Headrail Dimensions (inches)	Partially recessed headrail in window casing/ molding	Fully recessed headrail in window casing/ molding
Shade Type		Minimum Depth Mount (inches)	Flush with Casing (inches)
1" Pleat	1 1/16 x 2 1/8	3/8	2 3/8
2" Pleat	1 1/16 x 2 1/8	3/8	2 3/8

Control Type and Size Considerations

Perfect-Vue® Cordless Lift

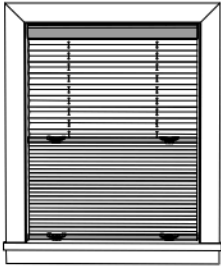

- For pricing, see price charts
- Perfect for combining light controls of sheer or light-filtering pleated fabric with blackout cellular fabrics
- Cordless lift shades are the safest window shade alternative; ideal for homes with children and pets
- 1" pleated can be combined with $\frac{9}{16}$ " single cell cellular fabrics only
- 2" pleated can be combined with $\frac{1}{2}$ " double cell or $\frac{3}{4}$ " single cell cellular fabrics only
- Headrail coordinates with pleated top fabric, bottomrail coordinates with bottom cellular fabric; midrail will match headrail as default
- Not available with multiple shades on one headrail
- All Perfect-Vue cordless lift shades need to be used on windows where consumers can comfortably raise and lower the shade with their hands and have easy access; operation of shade requires both sets of handles be used to properly raise and lower rails
- An optional sky pole is available for hard to reach shades 24" or less in width; if a sky pole is required for shades over 24" in width, two sky poles are recommended to ensure even operation

Size Considerations		Minimum Width* (inches)	Maximum Width (inches)	Minimum Height (inches)	Maximum Height (inches)
1" Pleat	All fabric styles	15	94**	12	86
2" Pleat	All fabric styles	15	94**	12	86

*For all inside mount applications, $\frac{3}{8}$ " deduction is taken by manufacturer on overall width.

**Maximum single shade width is 94" or maximum fabric width, whichever is smaller.

NOTE: Maximum area for 1" Aberdeen, Debonair, Sahara Ridge and Terrain is 6,400 square inches; 2" Debonair and Prescott is 5,800 square inches; 2" Marina and Sahara Ridge is 7,000 square inches, 2" Aberdeen, Cloud Metal and Terrain is 7,600 square inches.

Motorized Lift



- Refer to motorization product information guide for additional options, sizing, and pricing
- Window treatments can be operated from virtually anywhere in the home
- Provides easy operation of hard-to-reach or large window coverings
- Efficiently manages energy (heat gain and loss)
- Operate multiple window treatments simultaneously or individually
- A safer lift option; ideal for homes with children and pets
- Easily integrated with home automation systems
- Low voltage motorization requires no costly electrical hardwiring
- Multiple control and power options available, see motorization product information guide for options

NOTE: Motorization components and accessories have a five-year limited warranty, excluding batteries.



Control Type and Size Considerations

Continuous Loop Lift Shades

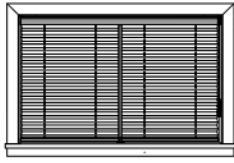
Fabric Styles	Fabric Width (inches)	Overlap Available	 Continuous Loop Lift (inches)				 Continuous Loop Lift Multiple Shades on One Headrail (inches)					
			Width		Height		Width			Height		
			Min†	Max	Min	Max	Min Panel†	Max Panel	Max Shade Single Control	Max Shade Multiple Controls	Min Shade	Max Shade
1" FashionPleat®												
Allure	72	• •	18½	120	9	96	18½	72	120	144	9	96
Desert	94	• •	18½	120	9	96	18½	94	120	144	9	96
Sheer Linen	72	•	18½	120	9	96	18½	72	120	144	9	96
1" EvenPleat®												
Aberdeen	92	• •	18½	120	6	96	18½	92	120	120	6	96
Allure	72	• •	18½	120	6	96	18½	72	120	120	6	96
Blackout Liner	72	•	18½	120	6	96	18½	72	120	120	6	96
Debonair	94	• •	18½	94	6	96	18½	94	120	120	6	96
Desert	94	• •	18½	120	6	96	18½	94	120	120	6	96
Inkblot	92	•	18½	92	6	96	18½	92	120	120	6	96
Privacy Liner	72	•	18½	120	6	96	18½	72	120	120	6	96
Sahara Ridge	94	•	18½	94	6	96	18½	94	120	120	6	96
Serendipity	92	•	18½	120	6	96	18½	92	120	120	6	96
Sheer Linen	72	•	18½	120	6	96	18½	72	120	120	6	96
Spring Bloom	92	•	18½	92	6	96	18½	92	120	120	6	96
Terrain	94	•	18½	94	6	96	18½	94	120	120	6	96
2" EvenPleat												
Aberdeen	92	• •	18½	144	12	120*	18½	92	144	144	12	120
Blackout Liner	72	• •	18½	144	12	120*	18½	72	144	144	12	120
Canyon Ridge	92	• •	18½	144	12	120*	18½	92	144	144	12	120
Cloud Metal	94	• •	18½	144	12	120*	18½	94	144	144	12	120
Debonair	94	•	18½	94	12	120*	18½	94	144	144	12	120
Desert	94	• •	18½	144	12	120*	18½	94	144	144	12	120
Grasscloth	72	•	18½	72	12	120*	18½	72	144	144	12	120
Marina	94	•	18½	94	12	120*	18½	94	144	144	12	120
Prescott	94	•	18½	94	12	120*	18½	94	144	144	12	120
Privacy Liner	72	•	18½	144	12	120*	18½	72	144	144	12	120
Sahara Ridge	94	•	18½	94	12	120*	18½	94	144	144	12	120
Serendipity	92	•	18½	144	12	120*	18½	92	144	144	12	120
Sheer Linen	72	•	18½	144	12	120*	18½	72	144	144	12	120
Terrain	94	•	18½	94	12	120*	18½	94	144	144	12	120

†For all inside mount applications, ½" deduction is taken by manufacturer on overall width.

*Height limited to 96" with overlap.

NOTE: Please refer to continuous loop lift area limit chart for size restrictions by fabric.

Depth Requirements for Inside Mount Continuous Loop Lift

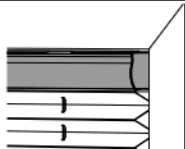
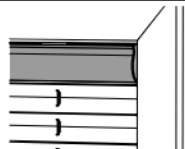
Shade Type	Headrail Dimensions (inches)	 Minimum Depth Mount (inches)	 Flush with Casing (inches)
1" Pleat	1 1/16 x 2 1/8	5/8	2 1/8
2" Pleat	1 1/16 x 2 3/8	5/8	2 1/8

Control Type and Size Considerations

Continuous Loop Lift

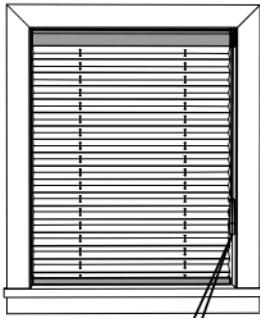

- For surcharges, see price charts
- Recommended for larger, heavier shades
- Larger shades use a larger clutch ratio for easier lifting, but additional pulls are required to raise the shade
- A single continuous loop cord raises and lowers the shade and keeps the cord the same length
- Safety locking cord tensioner included; cord tensioner must be installed for shade operation
- For inside mount, install the shade in the back of the window frame so the cord tensioner can be mounted in front of the shade and not interfere with shade operation. Additional mounting depth may be required.

NOTE: When ordered as multiple shades on one headrail, there can be either one or two controls. A single control on the left or right can be used on shades up to 120" wide to operate all panels. With two controls, the left control operates the left panel and the right control operates the right panel. For three panel shades, specify middle panel as control right or control left. Continuous loop controls cannot be located in the middle of a headrail.

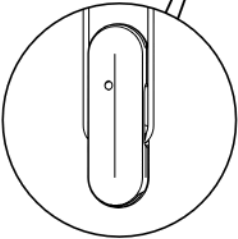

Size Considerations	Minimum Width* (inches)	Maximum Width† (inches)	Minimum Height (inches)	Maximum Height (inches)
1" FashionPleat®	18½	120	9	96
1" EvenPleat®	18½	120	6	96
2" EvenPleat	18½	144	12	120**

*For all inside mount applications, ¾" deduction is taken by manufacturer on overall width.

**Height limited to 96" with overlap.

†Based on fabric width with overlap.

Loop Cord Colors	
Smokey Gray	026
Tender Taupe	103
Vanilla	100
White	00

Tension Device Colors	
Clear	00
White	871
Cream	715

Continuous Loop Lift Area Limit Chart	
Fabric Style	Maximum Shade Size (square inches)
2" Aberdeen, Canyon Ridge, Cloud Metal, Debonair, Desert, Grasscloth, Marina, Prescott, Sahara Ridge, Serendipity, Terrain	9,000
1" Aberdeen, Debonair, Desert, Sahara Ridge, Serendipity, Spring Bloom, Terrain	11,000
1" Allure, Inkblot, Sheer Linen; 2" Sheer Linen	13,000
Liner only shades	17,000

Control length for continuous loop lift shades varies based on the finished shade height. Optional cord loop lengths are available and must be specified at the time of the order. The chart below lists the standard cord length.

Finished Shade Height	1" Pleated Continuous Loop Cord Length (inches)	2" Pleated Continuous Loop Cord Length (inches)
12 to 26	18	18
26½ to 38	24	24
38½ to 50	36	36
50½ to 62	48	48
62½ to 74	60	60
74½ to 96	72	72
96½ to 120	N/A	84

Optional cord lengths: 84", 96", and 108".

Options

Shade Liner

- For surcharge, see price charts
- Privacy or blackout liners are available on select styles with continuous loop and motorized lift systems
- Privacy liner is available with cordless lift as a single panel only (no overlap)
- Creates neutral to the street side appearance
- Create room-darkening effects by adding a blackout liner
- FashionPleat® privacy and blackout liner are not available as a shade alone
- Due to construction of shade, light will filter through the route holes even with a blackout liner

Optional liners increase privacy and light control.

Privacy Liner: Allows a small amount of light to enter the room for a greater sense of privacy. Inside objects appear as shadows.

Blackout Liner: Prevents light from entering for a high level of light control with maximum privacy, preventing even silhouettes from showing through. Due to construction of the shade, light will filter through the route holes even with blackout liner.

NOTE: For shade widths greater than fabric width and heights up to 60", the liners will overlap at the same location as the fabric overlap. For shade widths greater than fabric width and heights over 60", the liners will overlap in the center of the shade. Maximum finished shade width limited to 142" for 1" fabrics and 140" for 2" fabrics.

EvenPleat Loop Tape



- Ensures uniform pleat spacing from the top of the shade to the bottom, guaranteed for life
- Optional upgrade for select 1" pleated fabrics
- Comes standard on select 1" pleated fabrics and all 2" pleated fabrics

Multiple Shades on One Headrail

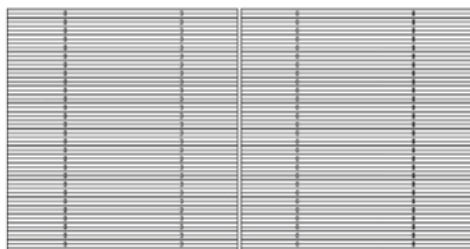

↑
Gap

- Surcharge for two or three shades on one headrail less than or equal to fabric width (see price charts)
- Shade widths exceeding fabric width made as two or three shades on one headrail—no charge
- Side mounts available
 - Single shade width: 60"
 - Multiple shades on one headrail: 42"
- Not available with bottom up/top down, sun up/sun down, or Perfect-View shades

Size Considerations		Maximum Overall Size for Multiple Shades* (inches)	Maximum Size with Side Mount (inches)	Control Locations	Gap (inches)
Continuous Loop Lift Single Control	1" FashionPleat	120 x 96	60 x 96	Two-on-one: Common lift cord can be on right or left to operate both shades at the same time Three-on-one: Common lift cord can be on right or left to operate all shades at the same time	½
	1" EvenPleat	120 x 96			
	2" EvenPleat	144 x 120			
Continuous Loop Lift Multi Control	1" FashionPleat	144 x 96	60 x 96	Two-on-one: Left shade, left control Right shade, right control Three-on-one: Left shade, left control Right shade, right control Middle shade, common lift cord to right or left shade. Continuous loop lift system cannot be used in the middle of the headrail on multiple shades	½
	1" EvenPleat	120 x 96			
	2" EvenPleat	144 x 120			
Cordless Lift	1" FashionPleat	144 x 86	60 x 96	Not applicable	¾
	1" EvenPleat	120 x 86			
	2" EvenPleat	144 x 86			

*See size considerations section for the minimum and maximum panel widths.

Options

Corner Windows

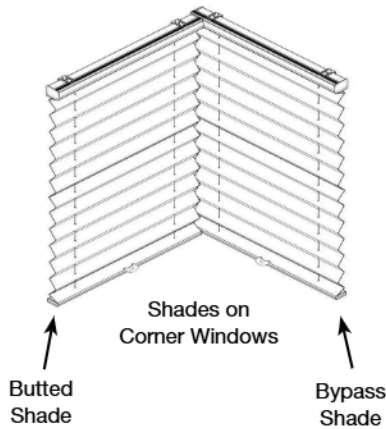

- No charge
- Made as individual shades
- Each shade will have its own control; we recommend opposite corners
- Indicate for each shade whether left or right and butt or bypass
- Bypass shade is mounted into the corner; butt shade is abutted to the other shade
- Manufacturer will take appropriate deductions for proper fit; DO NOT order as a corner shade if you do not want manufacturer to take deductions

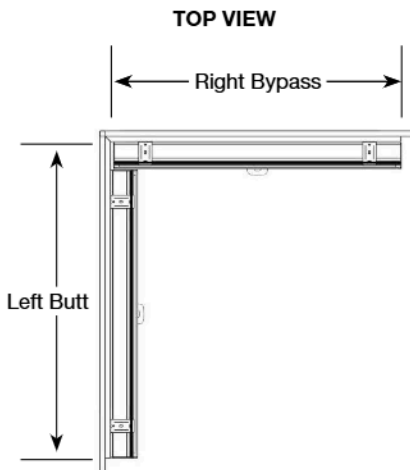

Measuring Information

Mounting on a Wall or Molding:

Measure the width of each window from the corner on the mounting surface (molding or wall) to the point you would like to cover.

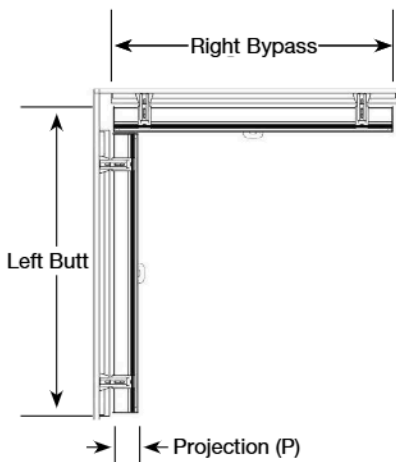

Mounting Above the Molding:

Measure the width of each window from the corner on the mounting surface to the point you would like to cover. Projection measurement is the distance needed to clear any molding or obstructions that the shade will be mounted above.

NOTE: The projection (P) distance is needed to correctly calculate deductions for installations where the shades will use shims or projection brackets to clear molding. All projection distances must match for correct deductions to be calculated.

Options

Bay Windows



Shades on Bay Windows

- No charge
- Made as individual shades
- Each section will have its own control
- Manufacturer will take appropriate deductions for proper fit; DO NOT order as bay window shade if you do not want manufacturing to take deductions

Measuring Information: Three-Sided Bay Window

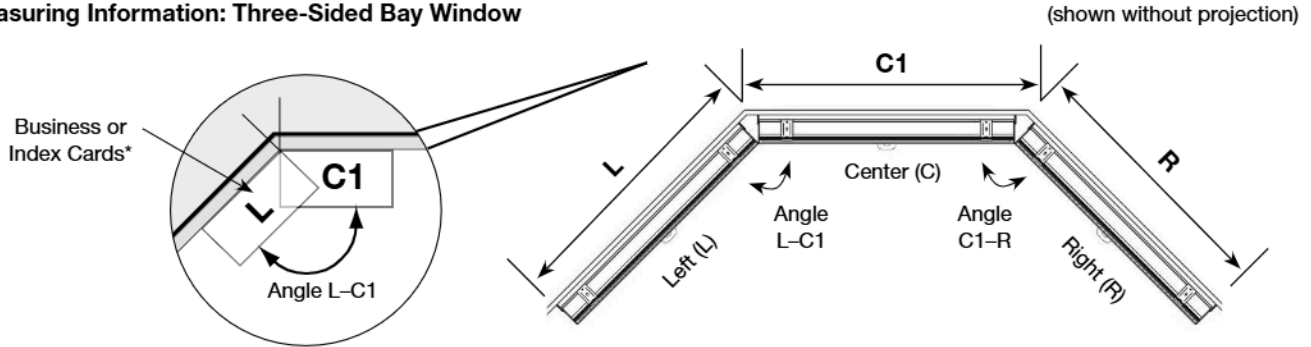

Measure:

- L and R:** Width of each side window from the corners on the mounting surface to the point you would like to cover.
- C1:** Width of the center window on the mounting surface from corner to corner.

- Angle L-C1:** Angle between the (L) and (C1) windows.
- Angle C1-R:** Angle between the (C1) and (R) windows.
- Projection:** If needed: The depth of the trim or molding the shade will be mounted above.

Measuring Information: Four-Sided Bay Window

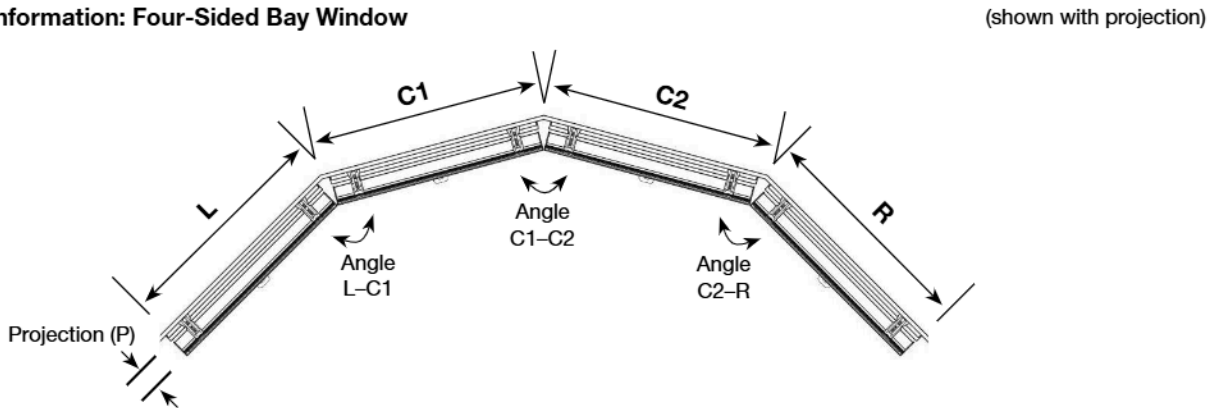

- L and R:** Width of each side window from the corners on the mounting surface to the point you would like to cover.
- C1, C2:** Width of each center window on the mounting surface from corner to corner.

- Angle L-C1:** Angle between the (L) and (C1) windows.
- Angle C1-C2:** Angle between the (C1) and (C2) windows.
- Angle C2-R:** Angle between the (C2) and (R) windows.
- Projection (P):** If needed: The depth of the trim or molding the shade will be mounted above.

NOTE: The projection (P) distance is needed to correctly calculate deductions for installations where the shades will use shims or projection brackets to clear trim or molding. All projection distances must match for correct deductions to be calculated.

For additional windows on bays with up to five sides continue with number progression for center shade sizes (C1, C2, C3, ...) and angles (Angle C1-C2, Angle C2-C3, ...) as needed.

*Measure each bay angle using a protractor or angle finder or use two business cards in each bay corner as illustrated above, trace on paper, and fax or email to customer service.

The angle to use between adjacent center bay windows along a straight section of wall is 180° (degrees).

Options

Specialty Shapes: Arch Shades

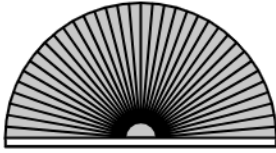

Perfect Arch: Half Circle



Palladian
(template required)
Illustration not to scale



Eyebrow Arch
(template required)

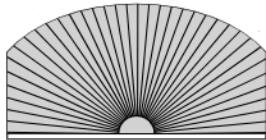

Elongated Arch
(arch with straight sides)
(template required)



Triangle
(template required)

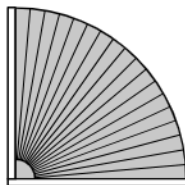

Quarter Circle
(template not required
if perfect quarter)

Perfect Arches (template not required)

- For surcharges, see price charts
- Perfect arches are those where the radius of the circle is constant at all points; height is exactly half the width
- Perfect quarter circle is where height and width are equal
- For inside mount, measure inside of window frame; for outside mount, add the desired amount of overlap to your measurements
- Include width and height measurements on all orders
- Side mount available up to 60" wide exact
- Liner available if fabric allows

Non-Perfect Arches (require a template)

- For surcharges, see price charts
- Non-perfect arches are those where the radius of the circle is NOT constant at all points; height is not exactly half the width
- Include width and height measurements on all orders
- For inside mount, measure inside of window frame; for outside mount, add the desired amount of overlap to your measurements
- See template instructions
- Side mount available up to 60" wide exact
- Liner available if fabric allows

NOTE: Arches can be made in EvenPleat® fabrics, however they will not have the back loop tape.

Size Considerations				
Specialty	Minimum Width* (inches)	Maximum Width (inches)	Minimum Height (inches)	Maximum Height (inches)
Perfect Arch, Half Circle	9	96	4½	48
Palladian, Elongated, Eyebrow and Triangle	9	96	20% of width; minimum 4½	60% of width; max of 57.5
Quarter Circle	9	43	9	1.5 times width; max of 64.5

*For all inside mount applications, ⅝" deduction is taken on overall width.

Recess Depth and Flush Mount	Minimum Recess Depth (inches)	Maximum Flush Mount (inches)
1" Pleated	1⅞	1⅞
2" Pleated	1⅞	2¼

Options

Specialty Shapes: Angled Top

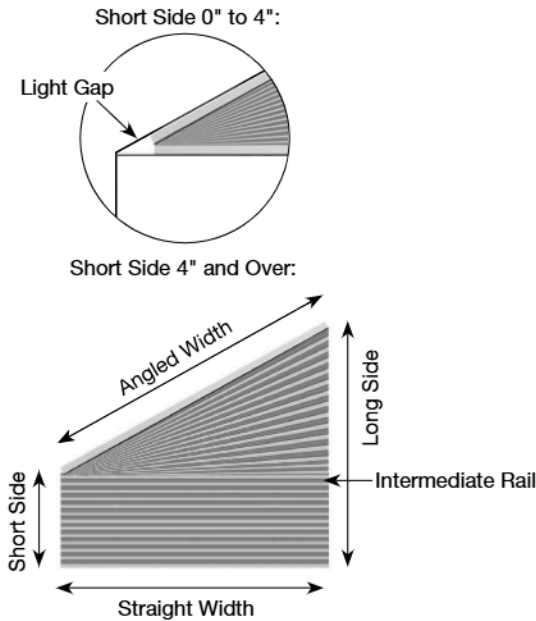

- Shade will be stationary
- As the low side measurement approaches 0", a light gap will exist to allow for the rails and fabrics to fit. For shades with short sides greater than 4", a light gap will exist but due to cut-back will be minimal.
- Not available as privacy or blackout liner only shades
- Only available with 1" pleated fabric
- Side mount not available
- Specify short side when ordering

Minimum Angled Width	12"
Maximum Angled Width	82**
Minimum Short Side Height	0"
Minimum Long Side Height	12"
Maximum Long Side Height	96"
Maximum Angled Top Degree	60° (degrees)

**Maximum angled width determined by fabric width minus 2".

NOTE: Angle will not have loop tape.

SkyTrack™ Skylight

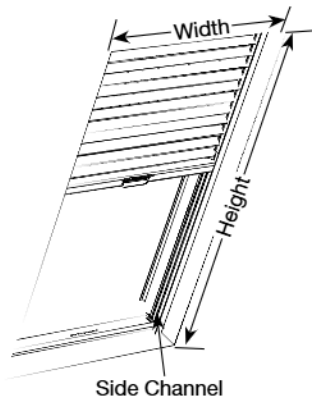

Sky Pole
 Sizes available:
 3 to 6½' and
 5 to 9½'

- **For surcharge, see price charts**
- Widths over 24¾" will have a center cord visible when the shade is open
- Includes color coordinated aluminum side channels; colors available: Canyon Gray 053, Cream 715, Creamy Pearl 356, Revere Pewter 190, Sable 565, Smokey Gray 026, White Satin 205
- Operates with handle on center rail
- Brackets will be visible on an outside mount
- Skylight poles are telescoping and available upon request
- Side mounts not available
- 90 degree corners at top and bottom are required for mounting
- Skylights only available in 2" EvenPleat® fabrics

Size Considerations	Minimum Recess (Inches)	Flush Mount (Inches)
Mounting Depth	1½"	2½"

Size Considerations	Minimum Width (inches)	Maximum Width* (inches)	Minimum Height (inches)	Maximum Height* (inches)
All Fabric Styles	12¾"	61"	12"	61"

*For a width of 30¾" or less, maximum shade height is 96".

Options

Making a Template for Specialty Windows

1. Tape butcher paper or heavy brown wrapping paper over the window opening allowing plenty of overlap.
2. Being careful not to press against the template paper while tracing, draw an exact outline of the window opening. Pressing on the template paper may distort the paper and cause the wrong size to be made.
3. Remove the paper from the window opening. If the shade is an outside mount, add the desired amount of overlap to the window outline. Draw a second outline around it to match the shape of the finished shade. **Be sure to erase the inside line.**
4. Mark the dimensions on the template. Check that the template dimensions match your measurements of the actual window opening.
NOTE: Make sure the template is of the window opening, not the measurement of the glass only.
5. Cut the shape from the paper.
6. **PLACE THE TEMPLATE BACK INTO THE WINDOW OPENING TO CHECK FOR PROPER FIT.**
7. Indicate on the template:
 - Room side and top
 - Purchase order number
 - Customer's name
 - Your store name and account number
8. Attach a copy of your purchase order to the template.
9. Roll up template and place in a mailing tube.
DO NOT FOLD TEMPLATE.

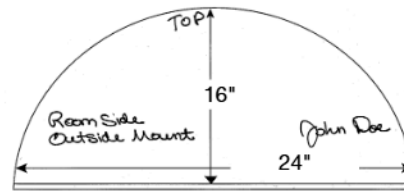

Mail to: SPRINGS WINDOW FASHIONS, LLC
8601 Route 405 Highway South, PO Box 500
Montgomery, PA 17752
ATTN: SPECIALTY DEPARTMENT

NOTE: When mailing, make sure to get a tracking number and note your return address on the mailing tube.

ACCEPTABLE MATERIALS FOR MAKING TEMPLATES

Kraft paper
Butcher paper
Construction paper

WE WILL NOT ACCEPT TEMPLATES MADE FROM THE FOLLOWING MATERIALS

Newspaper	Plastic
Wax paper	Fabric
Tissue paper	Roofing paper
Existing arch shades	Wrapping paper
Cardboard	Poster board

NOTE: If the material used to make a template stretches, tears easily, will not lay flat, or will mark the fabric, IT WILL NOT BE USED. If template is not pre-cut from paper, IT WILL NOT BE USED.

Using Template Service

For surcharge, see price charts

Template service is used when a customer is unable to make or supply a template.

To use the template service, simply:

1. Select template service when entering your order online.
2. Use the Specialty Shapes Reference Guide to determine what measurements you need to supply for each shape.
3. Enter the lettered measurements using line item comments. The comments have been pre-programmed to all of the measurements you need to enter for your special shape.

For additional information, contact customer service.

Options

Enhanced Light Control Features

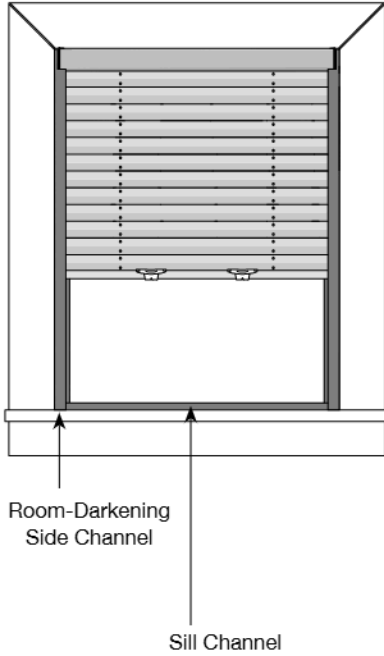

Lightblocking Strip

- Boost room-darkening performance by reducing light leakage between the window and headrail
- Ideal option for bedrooms, nurseries, and those who prefer blackout light control
- Available for pleated shades with cordless lift, continuous loop lift, and motorized lift controls

Room-Darkening Side Channels

- **For surcharge, see price charts**
- Side channels boost room-darkening performance by reducing light leakage at sides of shades between the fabric and window frame
- Sill channel boosts room-darkening performance by reducing light leakage between the bottomrail and window frame
- Aluminum side channels come with a black PVC insert to absorb light and reflect it back outside for enhanced light blocking
- Maximizes privacy
- Ideal option for bedrooms, nurseries, and those who prefer enhanced light control
- Available for 2" pleated shades with motorized lift or cordless lift
- Room-darkening side channel colors available: Canyon Gray 053, Cream 715, Creamy Pearl 356, Revere Pewter 190, Sable 565, Smokey Gray 026, or White Satin 205
- Maximum width and height is 120" x 120"

Room-Darkening Side Channels

Size Considerations	Minimum Mounting Depth (inches)
Side Channels	1¼
Side Channels with Sill Channel	2 ⁵ / ₈

General Information

Stack Height Chart

Height of Shade (inches)	1" Blackout Liner 1" Privacy Liner (inches)	1" Pleated Allure, Inkblot, Serendipity (inches)	1" Pleated Aberdeen, Desert, Sheer Linen, Spring Bloom (inches)	1" Pleated Debonair, Sahara Ridge, Terrain (inches)	2" Blackout Liner 2" Privacy Liner (inches)	2" Pleated Aberdeen, Canyon Ridge, Desert, Serendipity, Sheer Linen (inches)	2" Pleated Cloud Metal, Debonair, Marina, Prescott, Sahara Ridge, Terrain (inches)	2" Pleated Grasscloth (inches)
18	2¼	2%	2½	2%	2%	2%	2%	2¾
30	2%	2%	2¾	3%	2¼	2½	2%	3⅞
42	2%	2¾	3⅞	3%	2¼	2¾	3%	3½
54	2½	3	3%	4%	2%	2%	3%	3⅞
66	2%	3¼	3%	4%	2%	3	3%	4⅞
78	2%	3%	3%	5%	2½	3⅞	4	4½
90	2¾	3%	4¼	5¾	2½	3%	4¼	4⅞
96	2¾	3¾	4%	6	2½	3%	4%	5⅞
108					2%	3%	4%	5½
120					2%	3¾	4%	5¾
132					2%	3%	5%	6⅞
144					2¾	4	5½	6½

1" and 2" Pleated

For bottom up/top down with cordless lift controls add ¾".

For sun up/sun down with cordless lift controls, add the two fabric stacks together.

NOTE: Stack height includes headrail and bottomrail. The stack measurements above are approximate. All stack heights as shown are without overlap. For overlap, add an additional 60% to the given height for total stack height.

General Information

Stack Height Chart: Perfect-Vue®

All Pleated Fabrics Plus Cellular Fabrics Below				
Height of Shade (inches)	¾" Single Cell Sanctuary, Scroll FR, Simply Sheer (inches)	¾" Single Cell Enchantment LF & BO, Endeavor, Infuse BO, Kinsley BO, Montage LF & BO, Prestige BO, Valletta BO	½" Double Cell Splendor ¾" Single Cell Champagne Toast, Couture LF & BO, Discovery, Infuse LF, Kinsley LF, Prestige LF, Splendor, Valletta LF	½" Double Cell Sanctuary (inches)
18	2⅞	2¾	2⅞	3
30	2¾	3	3¼	3⅞
42	3	3¼	3⅞	3⅞
54	3¼	3⅞	4	4¼
66	3½	3⅞	4⅞	4¾
78	3⅞	4¼	4⅞	5⅞
86	3⅞	4½	5	5⅞

NOTE: Sizes are approximate.
 Stack height includes all rails and both pleated and cellular fabrics together, but is based on the cellular fabric chosen.
 Thickest pleated fabric was used for calculation.

General Information

Pleated Shade Color Coordination Chart

NOTE: Default color coordination is noted below. If desired, color coordination can be specified at the time of order.

Base Color	Default Rail Color	Rail Color Number
Aberdeen		
Dulcent Graphite	Online	187
Effervescence	Cream	715
Ingenu Pearl	White Satin	205
Pristine	White Satin	205
Allure		
Bone	Cream	715
Savvy Gray	Online	187
Shimmery Tan	Revere Pewter	190
Silver Lining	White Satin	205
White	White Satin	205
Canyon Ridge		
Arborio Rice	Cream	715
Bona Fide Taupe	Twine	439
Evening Storm	Online	187
Fading Nimbus	White Satin	205
Shadow Mist	Smokey Gray	026
Cloud Metal		
Candied Pecan	Watermelon Punch	196
Milky Way	White Satin	205
Pale Sage	Acacia Haze	182
Rosy Gray	Smokey Gray	026
Sediment	Revere Pewter	190
Shadowed	Cream	715
Debonair		
Charcoal Realm	Arctic Seal	183
Haberdasher Gray	Canyon Gray	053
Natural White	Cream	715
Unexpected Taupe	Quietude	188
Desert		
Abalone	Online	187
Chelsea	White Satin	205
Crystal	White Satin	205
Natural	Twine	439
Strata	Canyon Gray	053
Grasscloth		
Boardwalk	Camel	086
Crystal	White Satin	205
Fence Post	Iron Gate	185
Natural	Vanilla	100
Saddle	Sable	565
Safari	Sable	565

Base Color	Default Rail Color	Rail Color Number
Inkblot		
Coastal Gray	Online	187
Crystal	White Satin	205
Haven	Revere Pewter	190
Navy Mosaic	Navy	369
Marina		
Birchbark	Cream	715
Crystal	White Satin	205
Penguin	White Satin	205
Slate Rain	Online	187
Vault	Canyon Gray	053
Prescott		
Cocoa Nib	Revere Pewter	190
Gray Frost	Revere Pewter	190
Pale Rhino	White Satin	205
Sculpted Stone	Smokey Gray	026
Sahara Ridge		
Alabaster	White Satin	205
Birch Grove	Cream	715
Vapor	Cream	715
Serendipity		
Clouded Ash	Black Satin	233
Heavenly	White Satin	205
Muted Tan	Creamy Pearl	356
Sheer Linen		
Abstract Gray	Revere Pewter	190
Alabaster	Cream	715
Surreal Stone	Canyon Gray	053
White	White Satin	205
Spring Bloom		
Botanical Garden	White Satin	205
Cherry Blossom	White Satin	205
Cultivated Kalamata	White Satin	205
Sun-Kissed Olive	White Satin	205
Terrain		
Gray Frost	White Satin	205
Pale Adobe	Revere Pewter	190
Pale Rhino	Canyon Gray	053

General Information

Cordless Lift Product Detail

Side Mount Brackets (optional)

- Maximum width 60"

Projection Brackets (optional)

- Long (adds up to 2¼" extension from wall)
- Medium (adds up to 1¾" extension from wall)
- Short (adds up to ¾" extension from wall)

Aluminum Headrail

- Color coordinated to fabric

Internal Cord Lift System

- Prevents cords from tangling or rolling on top or each other
- Gear-driven for a smooth, operation and long-lasting life

Hidden Snap-In Brackets

- Zinc-plated steel
- Durable brackets designed for easy installation

Dust Cover

- Reduces build-up of dust and debris

Flush Mount End Caps

- Color coordinated to fabric
- Sleek look and tighter fit

Aluminum Bottomrail

- Color coordinated to fabric

Handles

- A simple push or pull raises or lowers the shade evenly

Hold Down Brackets (optional)

- Secures shade to doors, walls, and window sills

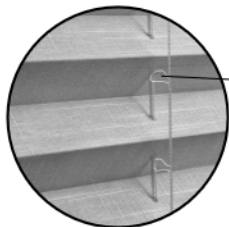

EvenPleat® Loop Tape (rear view of shade)

- Ensures uniform pleat spacing from the top of the shade to the bottom, guaranteed for life
- Color coordinated to the back of the fabric
- Optional upgrade for select 1" pleated fabrics
- Comes standard on select 1" pleated and all 2" pleated fabrics

NOTE: Not available with blackout liner

NOTE: All cordless lift shades need to be used on windows where consumers can comfortably raise and lower the shade with their hands and have easy access. Adding a sky pole is suggested for hard-to-reach applications, up to 24" wide. Sky poles are not recommended over 24"; however, if required, two sky poles should be ordered to ensure even operation. See options for details.

General Information

Continuous Loop Lift Product Detail

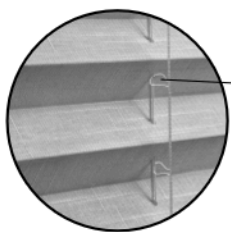
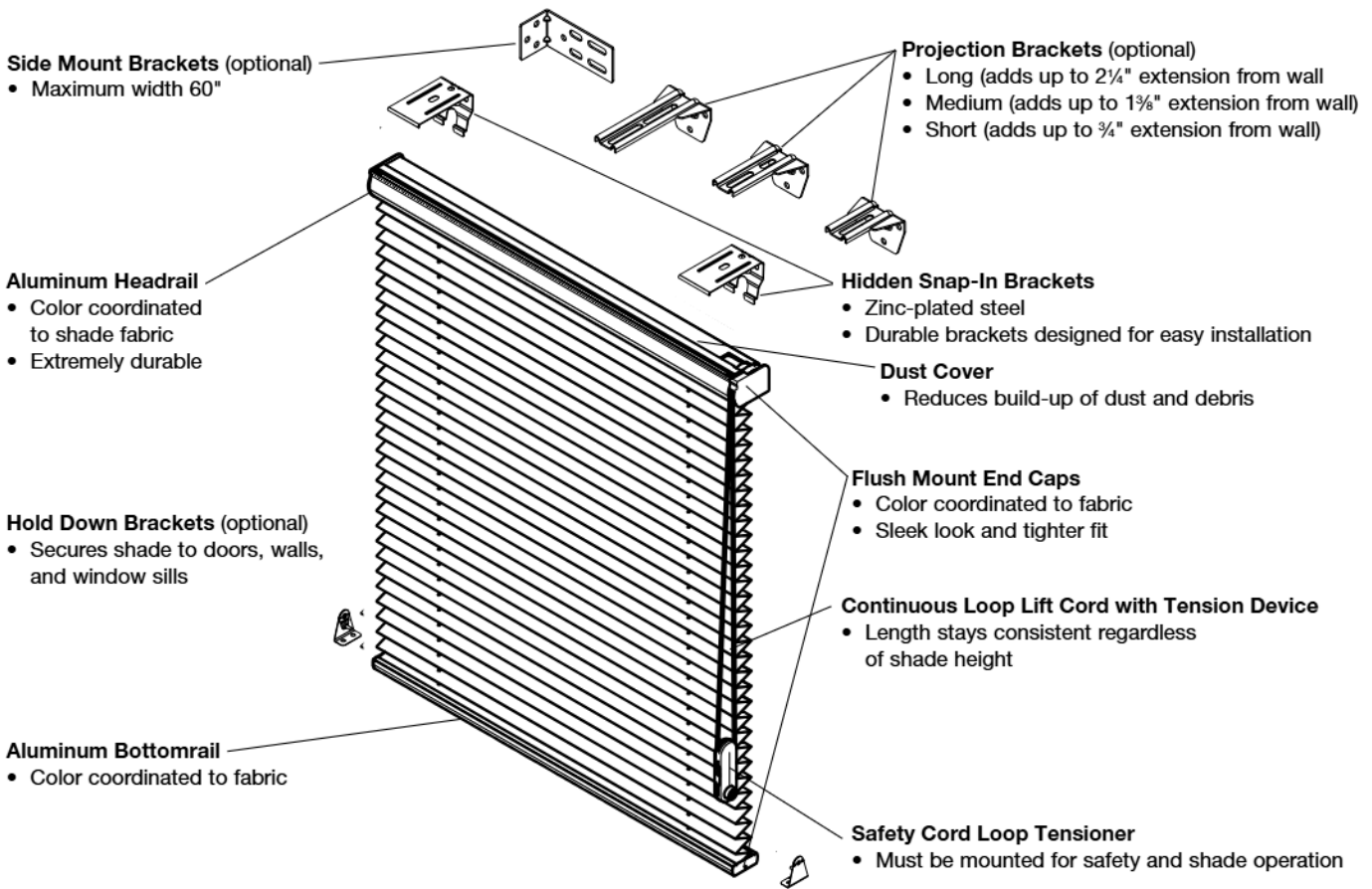

- EvenPleat® Loop Tape (rear view of shade)**
- Ensures uniform pleat spacing from the top of the shade to the bottom, guaranteed for life
 - Color coordinated to the back of the fabric
 - Optional upgrade for select 1" pleated fabrics
 - Comes standard on select 1" pleated and all 2" pleated fabrics

General Information

Bottom Up/Top Down: Cordless Lift Product Detail

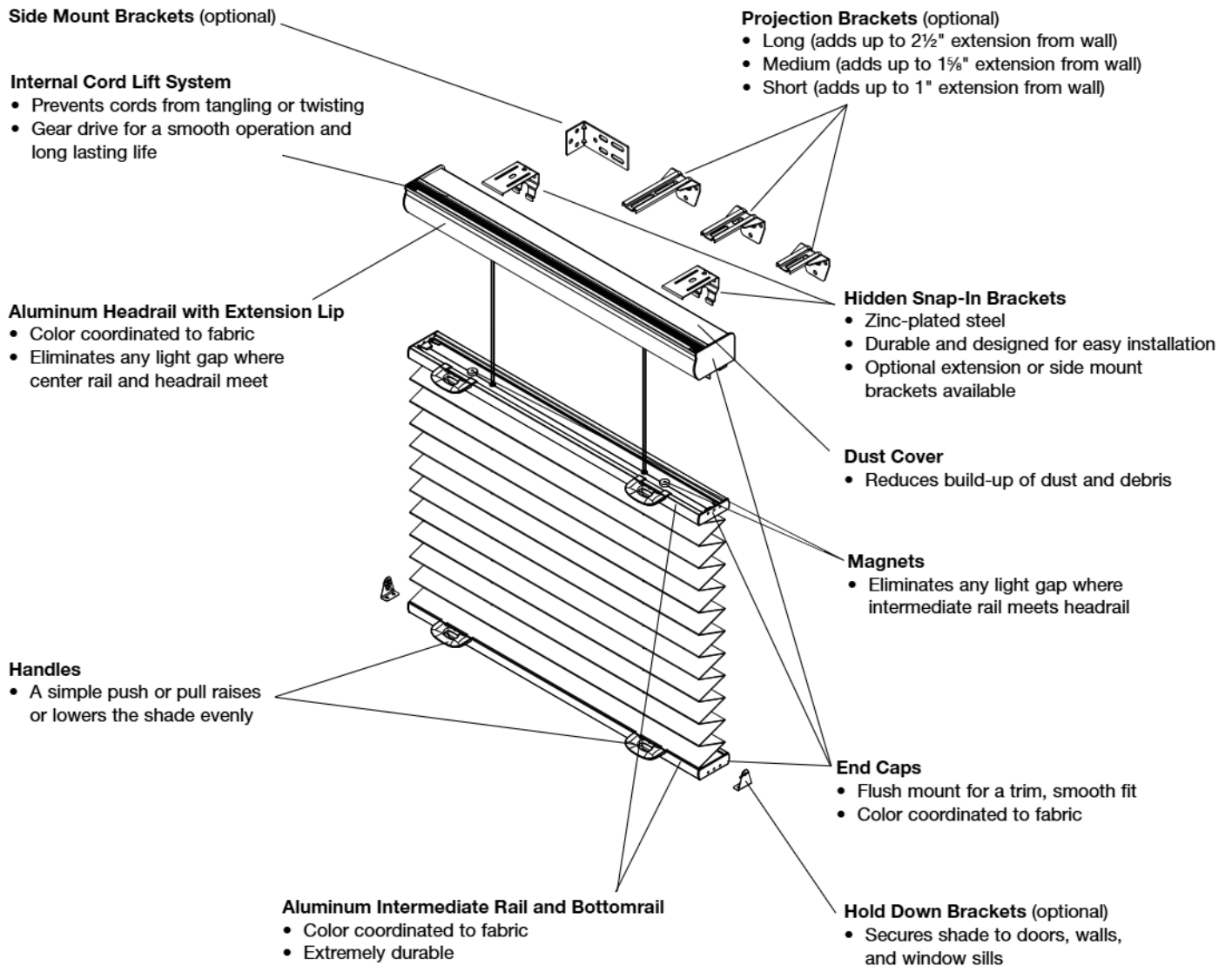

NOTE: Not available with blackout liner.

Cordless lift shades should only be used on windows where consumers can comfortably raise and lower the shade with their hands and have easy access.

General Information

Perfect-Vue® Cordless Lift Product Detail

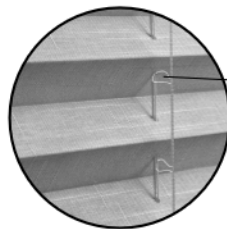
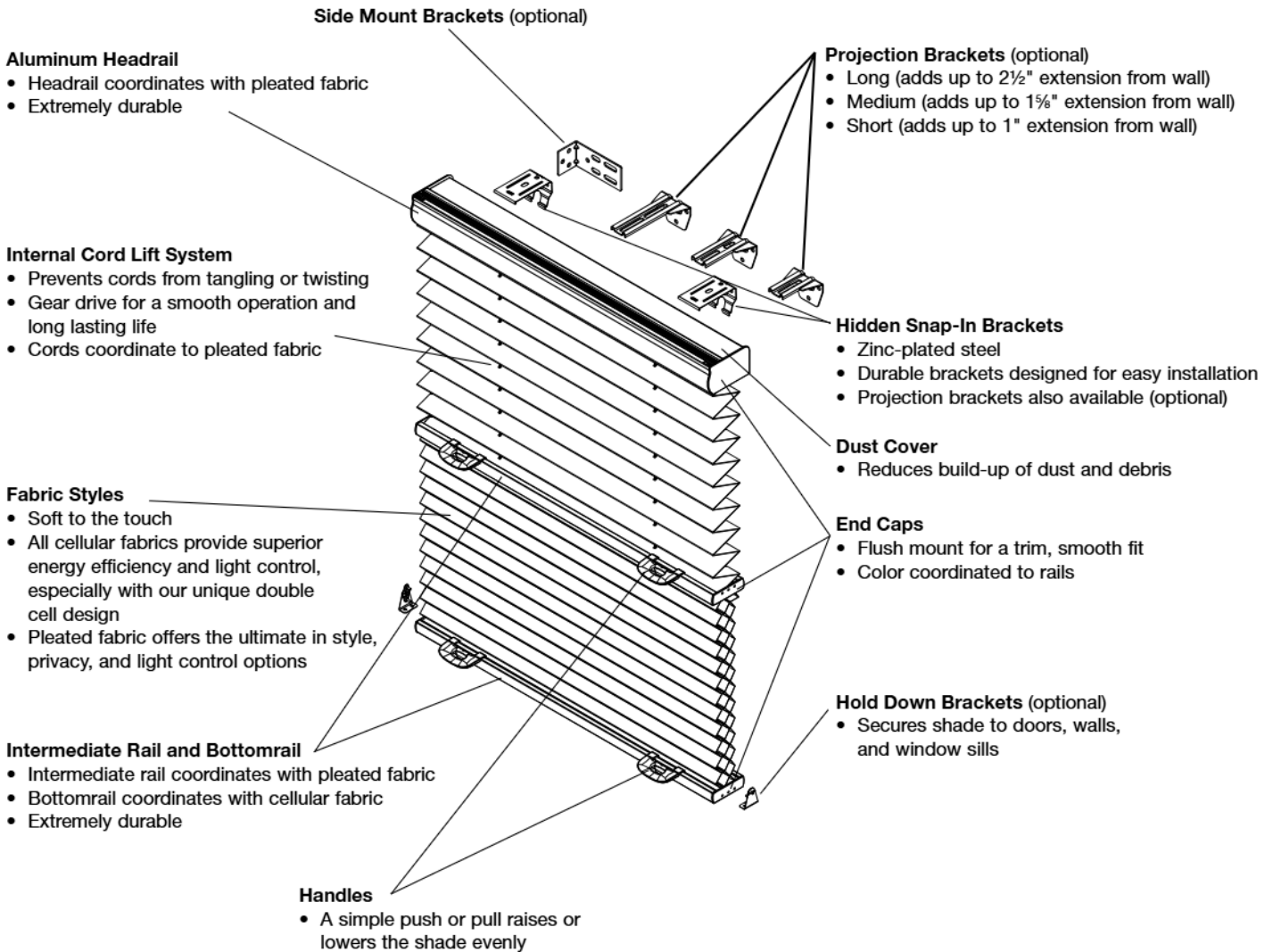

View From Back of Shade

EvenPleat® Loop Tape (rear view of shade)

- Ensures uniform pleat spacing from the top of the shade to the bottom, guaranteed for life
- Color coordinated to the back of the fabric
- Optional upgrade for select 1" pleated fabrics
- Comes standard on select 1" pleated and all 2" pleated fabrics

NOTE: Pleated portion not available with blackout liner.

Cordless lift shades should only be used on windows where consumers can comfortably raise and lower the shade with their hands and have easy access.